

MAINTENANCE

LUBRICATION

- Keep all working parts of the press well-oiled for easier operation.
- Keep a light film of oil over the entire surface of the ram to prevent rust.

EXPLODED VIEW & PARTS LIST

EXPLODED PARTS VIEW

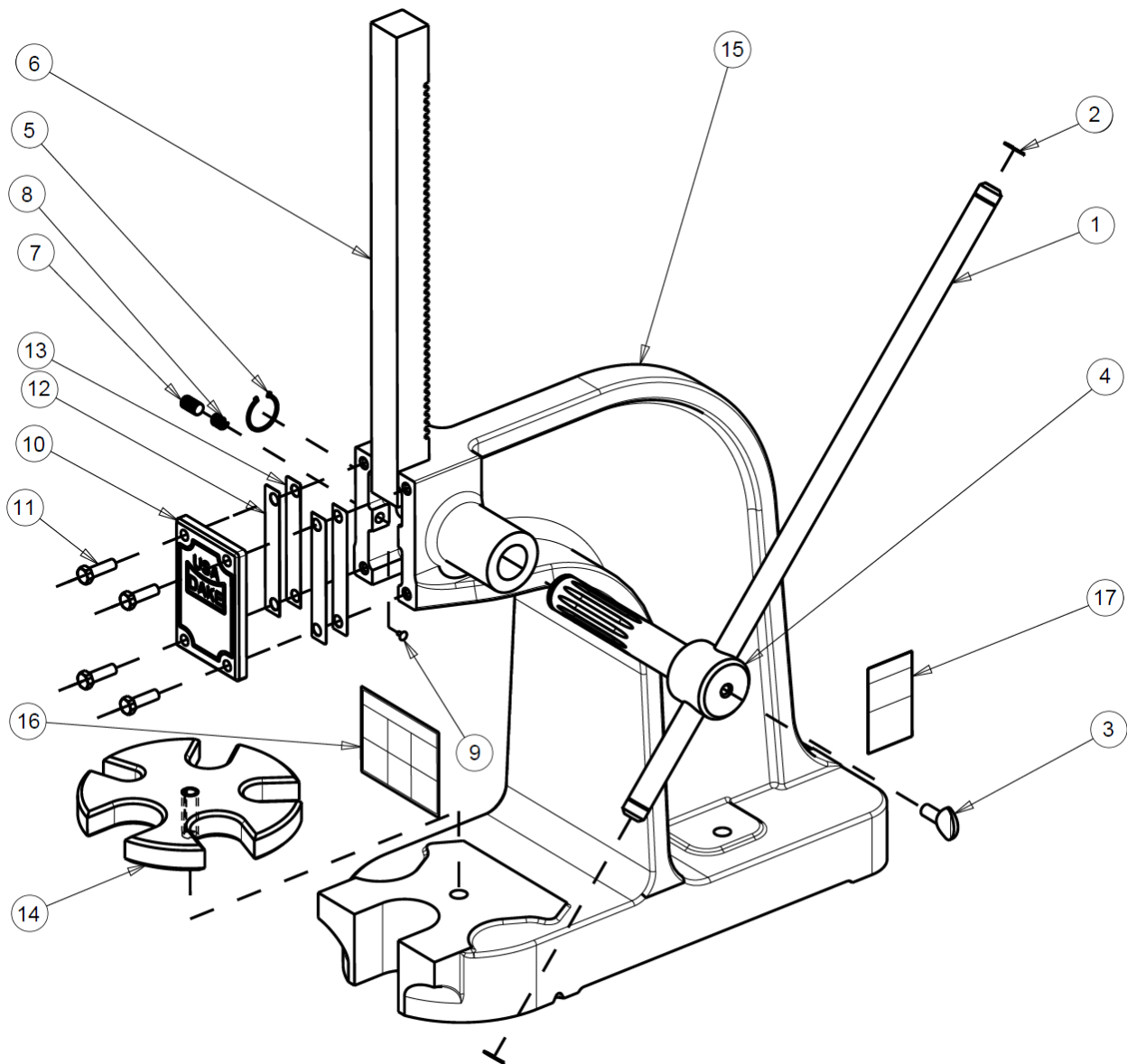



PARTS LIST

<u>Item</u>	<u>Part Name</u>	<u>Part Number</u>	<u>Qty</u>
1	Handle	149	1
2	Retaining Ring (National lock washer number XRC-331)	43971	2
3	3/8"-16 x 3/4" Thumb Screw	43622	1
4	Spindle	150	1
5	Retaining Ring	67424	1
6	Ram	147	1
7	3/8"-16 x 5/8" Headless Set Screw	43589	1
8	Brake Spring	108	1
9	Tinners Rivet	43577	1
10	Ram Cap	142	1
11	5/16"-18 x 1" Hex Cap Screw	43315	4
12	Ram Cap Shim (.008")	145	2
13	Ram Cap Shim (.015")	146	2
14	Table Plate Assembly	700807	1
15	Frame	138	1
16	Warning Label – Ganged	300168	1
17	Warning Label – Tipping	79979	1

Please contact factory for current prices.

ORDERING INFORMATION

Parts are available for direct purchase from Dake or through a distributor. When placing a parts order, you will need to provide the part number, name of part, and model number. All parts shipped F.O.B. Factory in Grand Haven, MI.